





Pull-ARC 250 LAB

Électrodes - Electrodos / Consommables - Consumibles

Aluminium - Aluminio

Consommables - Consumibles

011048 AIMg3 1,0 mm (50 pcs) 

011046 AIMg3 1,5 mm (50 pcs) 

011049 AIMg3 1,0 mm (50 pcs) 

011047 AIMg3 1,5 mm (50 pcs) 

011052 AIMgSi 1,0 mm (50 pcs) 

011050 AIMgSi 1,5 mm (50 pcs) 

011053 AIMgSi 1,0 mm (50 pcs) 

011051 AIMgSi 1,5 mm (50 pcs) 

011054	AIMg3 Ø 4	(50 pcs)	
Tige de traction Traction nail			
010966	Ø 4	(1 pc)	
Pince Abrazadera			
010967	Ø 5	(1 pc)	
Pince Abrazadera			
011061	90 mm	(1 pc)	
Piquet de terre du pistolet Varilla de tierra de pistola			
010059	AIMg3 M4x16	(100 pcs)	
Rivets filetés Remaches de hilo			
010974	AlSi M5x20	(100 pcs)	
Rivets filetés Remaches de hilo			

011055 KDA1 Kit anneaux de traction AIMg3 Kit arandelas AIMg3



011048 AIMg3 1,0 mm (50 pcs)
011046 AIMg3 1,5 mm (50 pcs)



011049 AIMg3 1,0 mm (50 pcs)
011047 AIMg3 1,5 mm (50 pcs)

011056 KDA2 Kit anneaux de traction AIMgSi Kit arandelas AIMgSi



011052 AIMgSi 1,0 mm (50 pcs)
011050 AIMgSi 1,5 mm (50 pcs)



011053 AIMgSi 1,0 mm (50 pcs)
011051 AIMgSi 1,5 mm (50 pcs)

010081 KDA3 Kit Tige de traction - Kit de barra de tracción



011044 250 mm (1 pc)



011054 AIMg3 Ø 4 (50 pcs)



010966 Ø 4 (1 pc)

Acier - Acero

Consommables - Consumibles

010990 (10 pcs) 

Rondelles ovales
Arandelas ovaladas

010991 (10 pcs) 

Rondelles ovales pliées
Arandelas ovaladas plegadas

010757 M5x18 (100 pcs) 

Rivets filetés
Remaches de hilo

010759 Ø 5x25 (100 pcs) 

Goujont auto-filetant
Remaches autoenroscables

010760 Ø 5x18 (100 pcs) 

Goujont auto-filetant
Remaches autoenroscables

011059 (1 pc) 

Électrode pour rondelles ovales
Electrodo para arandelas ovaladas

011060 114 mm (1 pc) 

Piquet de terre du pistolet
Varilla de tierra de pistola

010986 (M4) (5 pcs) 

010987 (M5) (5 pcs)

Rondelles filetes
Arandelas de hilo



Pull-ARC 250 LAB



011045
Kit de marteaux en aluminium
Martillos de aluminio

Lavier - Palanca

010200 850 mm (1 pc)
KPSH1 KIT Barre debosselage
KPSH1 KIT Travesa de tiro

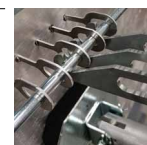
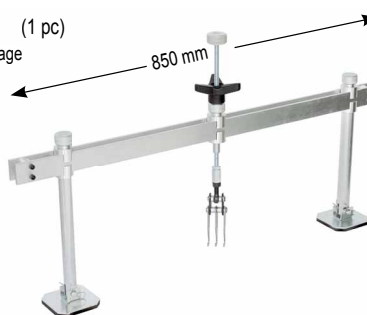

010312 700 mm (1 pc)
KPSL1 Levier
KPSL1 Palanca



011044 250 mm (1 pc)
Barre debosselage
Travesa de tiro



011063 250 mm (1 pc)

011064 500 mm (1 pc)

Tige de traction
Varilla de tracción



272791 Pull ARC 250 Basic Kit



NOT CONTRACTUAL



272700
Pull Arc 250 LAB



010966 ø 4 (1 pc)



011054 AIMg₃ ø 4 (50 pcs)



011044 250 mm (1 pc)



011046 AIMg₃ 1,5 mm (50 pcs)



011050 AIMgSi 1,5 mm (50 pcs)

010889
Chariot CR28
Carro CR28



011047 AIMg₃ 1,5 mm (50 pcs)



011051 AIMgSi 1,5 mm (50 pcs)



yellow energy

DECA S.p.A.
47891 Falciano - Repubblica di San Marino - tel. 0549 910711

www.decaweld.com

